

MAP

ASPIRATORE VENTILATORE CENTRIFUGO
CENTRIFUGAL FAN



GIRANTE A PALE CURVE AVANTI
FORWARD CURVED BLADES IMPELLER



ALTA PRESSIONE
HIGH PRESSURE

Portata/Flow rate:
100 ÷ 1400 m³/h

Pressione/Pressure:
60 ÷ 380 mm H₂O



MAP

ASPIRATORE VENTILATORE CENTRIFUGO CENTRIFUGAL FAN



I ventilatori della serie MAP sono indicati nel campo delle macchine sabbiatrici o per la lavorazione di materie plastiche. L'esecuzione standard prevede l'utilizzo di coclee in lamiera di acciaio con profili bordati, giranti a pale avanti in lamiera zincata e l'installazione di motori elettrici a 2 poli. I fluidi trasportati possono raggiungere una temperatura massima di 80°C in esecuzione standard; nel caso di esecuzioni speciali, sono ammessi valori massimi di 180°C. A richiesta sono disponibili esecuzioni in acciaio inossidabile, anche in conformità alla direttiva ATEX (2014/34/UE).

MAP series blower are suitable for sanding or plastic materials machines. Standard execution blowers are provided with edged steel sheets casings, forwarded galvanized blades impellers and 2 poles electrical motors. Transported fluids can reach maximum temperature of 80°C for standard execution; for special executions maximum values of 180°C are allowed. On demand, special stainless steel execution are available, also according to ATEX directive (2014/34/EU).

Orientamento RD 270
Position RD 270

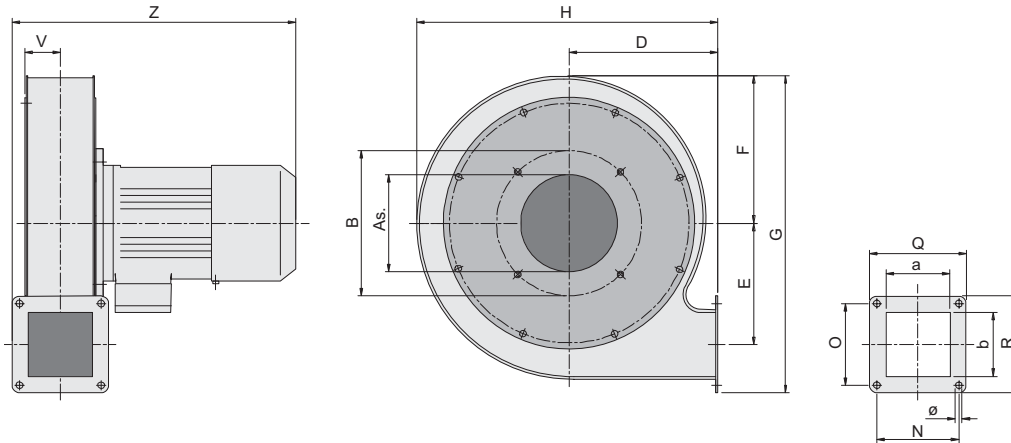

Direzioni di rotazione (vista lato motore) - Rotation senses (seen from motor side)

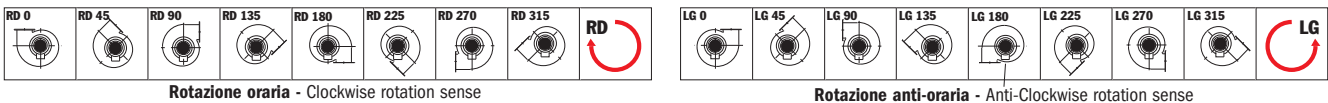

Rotazione oraria - Clockwise rotation sense

Rotazione anti-oraria - Anti-Clockwise rotation sense

Peso ventilatore in Kgf (completo di motore) - Weight of ventilator (complete with motor)

Nota: quota Z indicativa - Note: 'Z' quote indicative

TIPO - TYPE		kW inst.	PESO WEIGHT	VENTILATORE FAN																
VENTILATORE FAN	MOTORE MOTOR			kgf	As.	B	ø ₂	D	E	F	G	H	a	b	N	O	Q	R	V	Z
MAP 160	56 M2	0,09	5,5	124	-	-	108	100	115	260	235	51	51	70	70	89	89	31	220	7
MAP 200	63 M2	0,18	7,5	100	150	M6	147	115	138	305	292	61	61	85	85	105	105	37	255	7
MAP 250	71 M2	0,37	14	112	150	M6	165	145	166	370	340	66	66	95	95	118	118	40	280	9
MAP 280	71 M2	0,55	16	120	195	M6	182	155	180	400	380	86	86	110	110	130	130	48	300	9
MAP 300	80 M2	0,75	21	130	195	M6	200	163	198	426	405	86	86	110	110	130	130	48	325	9
MAP 350	90 S2	1,5	30	140	195	M6	217	202	238	510	460	91	91	115	115	140	140	51	355	9
MAP 400	90 L2	2,2	33	162	222	M6	248	229	255	560	525	91	91	115	115	141	141	51	380	9

DIRETTAMENTE ACCOPPIATI CON MOTORE A 2 POLI

DIRECT CONNECTION FOR 2 POLES MOTORS

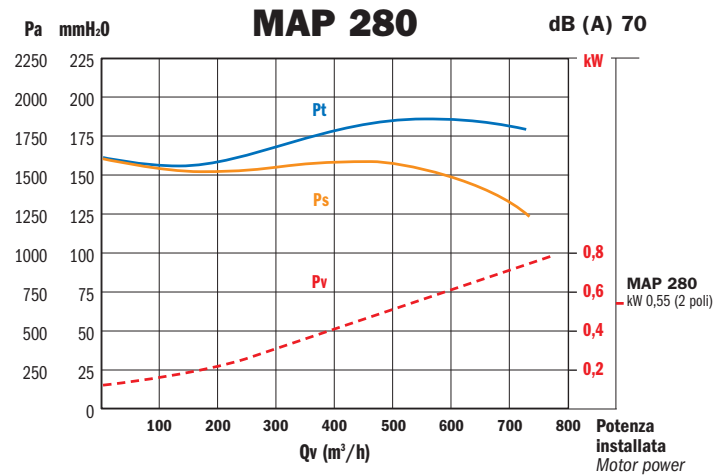
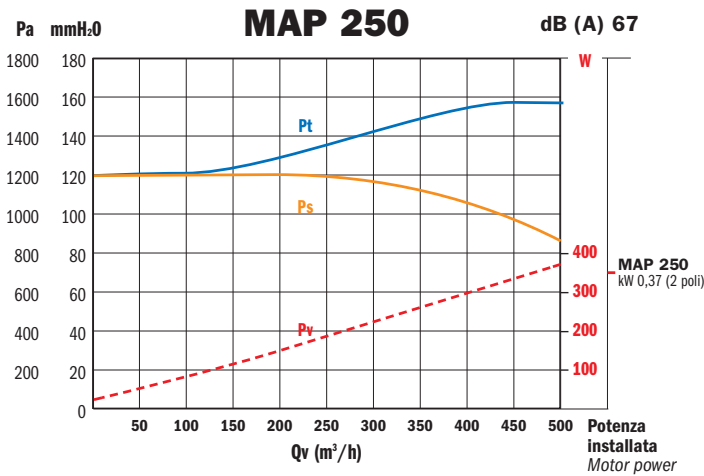
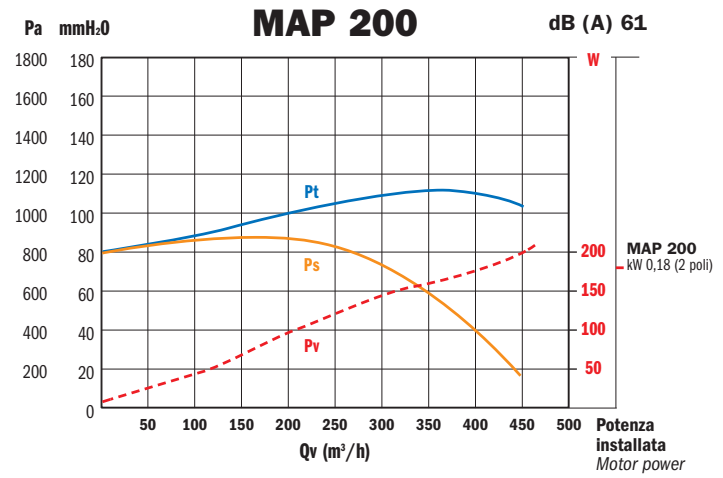
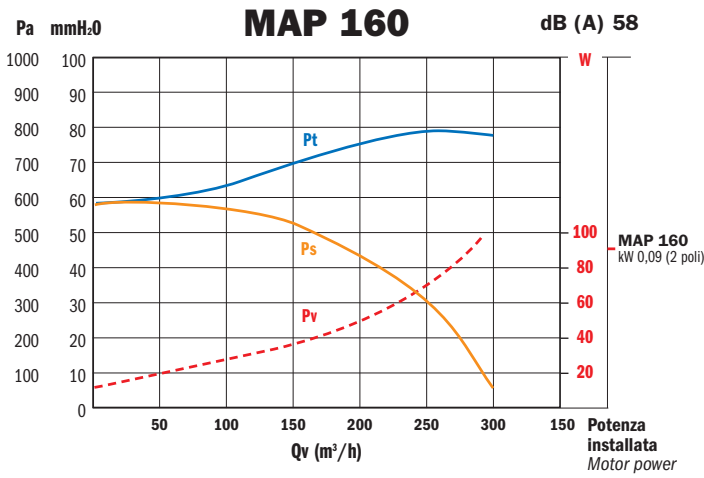

Valori riferiti a:/ Datas referring to: **T=15°C; P=1 atm**

— Pt= Pressione totale - Total pressure — Ps= Pressione statica - Statical pressure - - - Pv= Potenza assorbita - Absorbed power



DIRETTAMENTE ACCOPPIATI CON MOTORE A 2 POLI

DIRECT CONNECTION FOR 2 POLES MOTORS

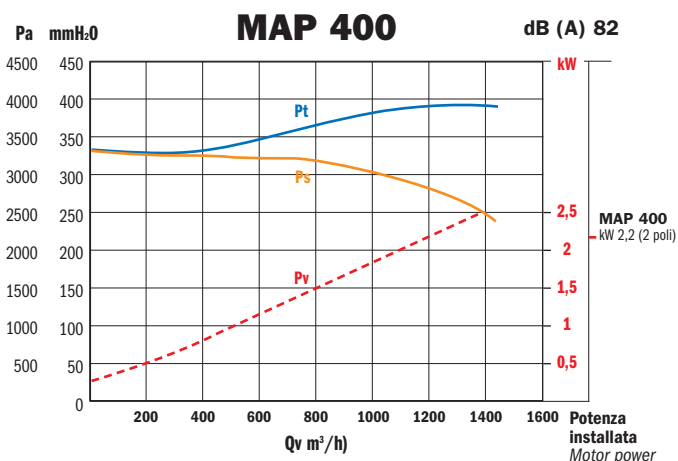
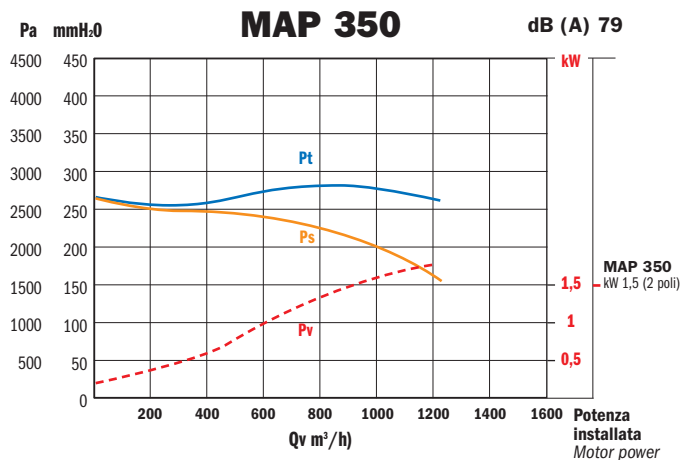
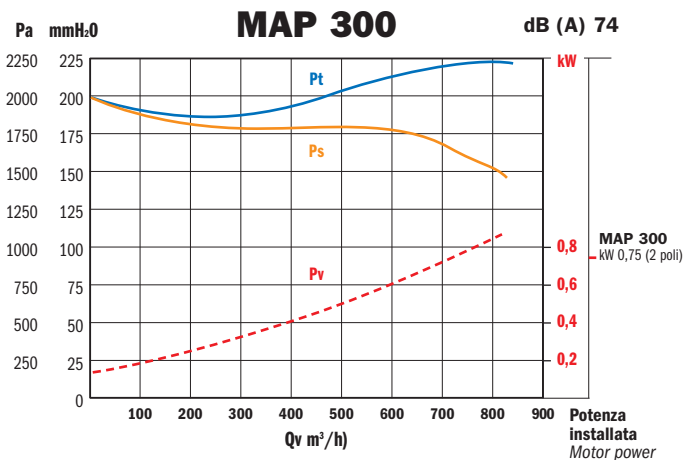

Valori riferiti a: / Datas referring to: T=15°C; P=1 atm

— Pt= Pressione totale - Total pressure — Ps= Pressione statica - Statical pressure - - - Pv= Potenza assorbita - Absorbed power